

Castor D75 fixed Fitting Plate, bright zinc-plated

Product number M-100

Weight 0.2kg

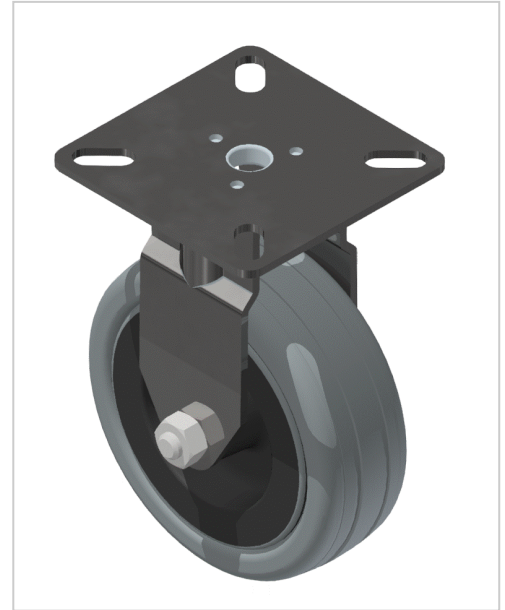

Product description

Swivel and fixed castors are used on assemblies and frames of all kinds. They have very good rolling characteristics and are highly resilient. The castors are resistant to many environmental influences.

Product properties

Roll type	Fixed castor
Mounting type	Screw-on plate
Part type	Apparatus castors
Roller diameter	Ø 75 mm
Lean system type	D28 steel kit system
Load capacity	60 kg

More images

